

PLS Competent
Air Curtains Electric
With quick guide

PLSAC

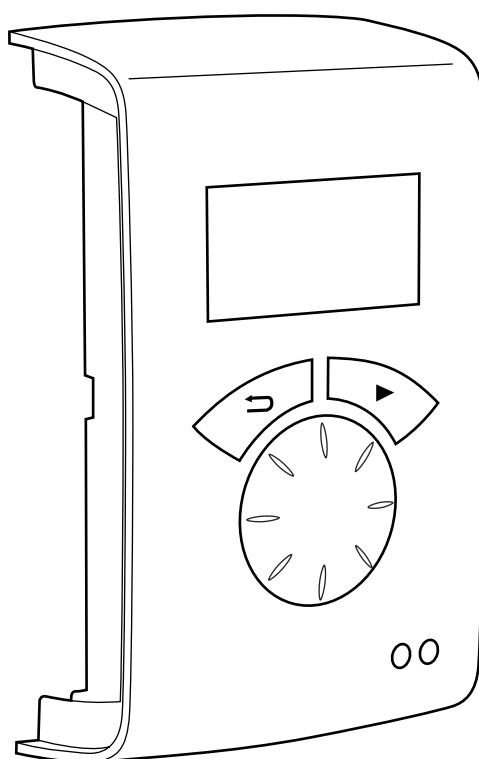

GB

For wiring diagram, please see last pages

Quick guide/start up

Check that all constituent parts are present (see section Constituent parts).

Advice about location

PC board HUB PLSC1X is installed close to the unit.

Control unit PLSUA1 has an integrated room temperature sensor and is installed so that it is easily accessible to the user. RJ12 (6p/6c) modular cables, which are available in different lengths, are used to connect the PC board and the control unit. Longer cables are available as options. Maximum cable lengths see section Options.

To prevent unauthorised people from accessing the Control unit it can instead be placed in another area and an external room sensor, PLSRTX (option), can be installed in the premises to sense the correct temperature.

Connect the system

In PC board Base PLSB1(X) the unit is connected further with RJ12 (6p/6c) modular cable if several units are to be connected in parallel.

If an external room temperature sensor PLSRTX (option) is used it is connected using modular cable RJ11 (4p/4c) on HUB PLSB1(X).

Door switch DC is connected to the terminal block on PC board HUB PLSC1X.

PC board Base PLSB1(X) in/at the unit and control unit PLSUB1 is connected with RJ12 (6p/6c) modular cable after the other units are powered up.

Power supply for electric heat must be connected separately (check manual for the air curtain unit).

Wiring diagrams

The wiring diagrams are in a separate section at the end of this manual.

When external PC board Base PLSB1X is used, wiring between the PC board base and the air curtain unit must be done. Please see separate manual for PLSB1X.

Enter ID/Operation without control unit

The control system can control one or more units in parallel (max 9). Each unit must get a unique ID number (1-9) which is set in the ID selector of the PC board. E.g. Unit 1: ID=1, unit 2: ID=3

If the external control for some reason has not been installed the unit can still be run temporarily. The ID selector is then set to mode 0 see the image below.

When the ID number must be changed the unit must be disconnected from power.

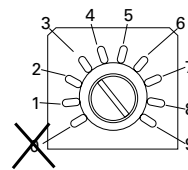

Each unit should have a unique ID on its PLSB1X card.
Start up

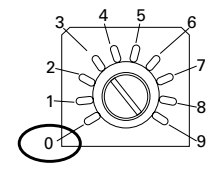

To run the unit temporarily without external control select mode 0.

System supplied with power. At the first start up, the start-up wizard is run and the basic settings are made. Fan and heating steps are tested through the test program. Then a status window is displayed.

At the first start up alarm and error codes can occur, these will usually be reset without actions.

Start-up wizard

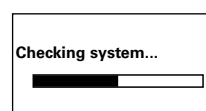
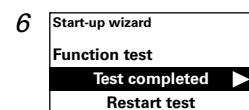
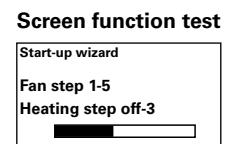
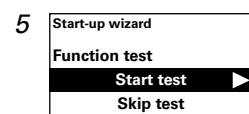
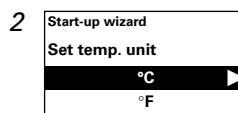
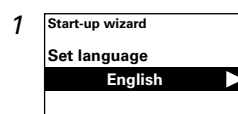

Contents

Quick guide/start up

Advice about location	2
Connect the system	2
Wiring diagrams	2
Enter ID/Operation without control unit	2
Start up	2

Constituent parts

PLSAC	4
-------	---

Operating modes

Door that is opened and closed	6
Doors that are always or often left open for longer periods	6
Function description of current stage	7

Control unit PLSUA1

Overview	9
Statuswindow	9

Main menu

Current settings	10
Temperature settings	10
Fan control	10
Summer/Winter	10
System on/off	10
Installer menu	10

Installer menu

Installer status screen	11
Week program	11
Fan settings	12
Heating settings	12
Filter guard settings (not for electric)	13
External control (BMS)	14
General settings	15
Service menu	15

Alarm and error codes

Displaying alarm and error codes	16
Reset alarm	16
Power failure	16
Overheat protection	16
Wiring diagrams, see last pages	

Constituent parts

PLSAC

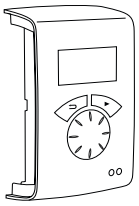

PLSUA1,
control unit
Competent and
Advanced

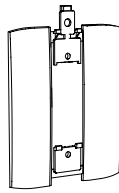

Wall unit cover

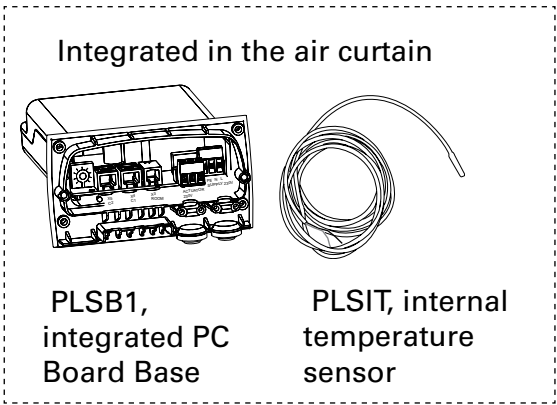

Integrated in the air curtain

PLSB1,
integrated PC
Board Base

PLSIT, internal
temperature
sensor

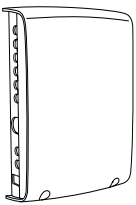

PLSC1X,
PC board HUB
Competent

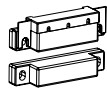

DC,
door contact

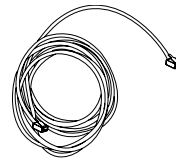

CC,
modular cable

Dimensions constituent parts

Type	Description	HxWxD [mm]	L [m]
PLSUA1	Control unit Competent and Advanced	120x70x35	
PLSB1	Integrated PC board Base		
PLSIT	Internal temperature sensor		1
PLSC1X	PC Board HUB Competent	202x139x50	
DC	Door contact		
CC603	Modular cable RJ12 (6/6)		3
CC605	Modular cable RJ12 (6/6)		5

Option

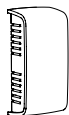

PLSRTX, external room temperature sensor

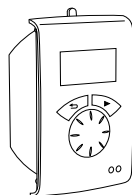

PLSUR, kit for recessed installation



CJ4, joint piece



CJ6, joint piece

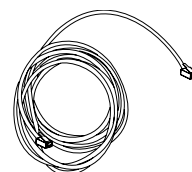

CC, modular cable

Type	RSK-no.	E-no.	Description	HxWxD [mm]	L [m]
PLSRTX	673 09 22	87 510 12	External room temperature sensor	70x33x23	10
PLSUR*	673 09 21	87 510 11	Kit for recessed installation	114x70x50	
CJ4			Joint piece for two pcs. RJ11 (4/4)		
CJ6			Joint piece for two pcs. RJ12 (6/6)		
CC603	673 09 23	87 510 13	Modular cable RJ12 (6/6)		3
CC605	673 09 24	87 510 14	Modular cable RJ12 (6/6)		5
CC610	673 09 25	87 510 15	Modular cable RJ12 (6/6)		10
CC615	673 09 26	87 510 16	Modular cable RJ12 (6/6)		15
CC403	673 09 27	87 510 17	Modular cable RJ11 (4/4)		3
CC405	673 09 28	87 510 18	Modular cable RJ11 (4/4)		5
CC410	673 09 29	87 510 19	Modular cable RJ11 (4/4)		10
CC415	673 09 30	87 510 20	Modular cable RJ11 (4/4)		15

*) See separate manual.

Max. cable lengths

- Modular cable RJ12 (6p/6c) between PLSUB1 and PLSB1(X): max 50 m.
- Modular cable RJ12 (6p/6c) between PLSC1X and PLSB1(X): max 10 m
- Modular cable RJ12 (6p/6c) between two PLSB1(X): max 50 m.
- Modular cable RJ11 (4p/4c) to room sensor PLSRTX: max 20 m.

Total cable length permitted in the system is a maximum of 300 m.

Operating modes

Door that is opened and closed

The control function notes whether the door is open or closed as standard, this mode is default set and is called Fixed flexible (the setting is under Installer menu > Fan settings > Door mode).

Open door

Indicates OP on the installer status screen. The fan speed runs at high speed which is set under Main menu > Fan speed > Max fan speed.

Normally it is requested that heat is engaged when the door is opened. The set point value (Room temp. day) is then increased with the fixed set point value difference that can be changed under Installer menu > Settings heating > Open door setp. diff., factory setting 3.0 K. The set point is set under Main Menu > Temperature settings > Room temp. day. If week program is used the night time set point value is set under Main menu > Temp. settings > Room temperature night. The room temperature is regulated using the integrated room temperature sensor or the external room temperature sensor, PLSRTX (option).

Closed door

Indicated CL on the installer status screen. When heating demand the fan speed runs at low speed which is set under Main menu > Fan speed > Speed closed door. Heating is regulated to Room temp. Day which is set under Main Menu > Temperature settings > Room temp. day.

If week program is used the night time set point value is regulated against the Room temperature is set under Main menu > Temp. settings > Room temperature night. The room temperature is regulated using the integrated room temperature sensor or the external room temperature sensor, PLSRTX (option).

When the door is closed - over run

When the door has been closed, high speed mode remains during the fixed time that is set under Installer menu > Settings fan > Door over run > High speed over run and at low speed during a fixed time under Installer menu > Settings fan > Door over run > Low speed over run, on the condition that it is sufficiently warm in the premises, otherwise the fans run until the desired temperature has been reached.

When the door is closed, the set point value shifts from room temperature + fixed set point value difference for open door to Room temp. day/night.

Over run is factory set so that the over run times are controlled according to how often the door is opened (Auto mode under Installer menu > Settings fan > Over run door > Over run mode).

Doors that are always or often left open for longer periods

If a door is always, or often, left open it is possible to use a function called CURRENT STAGE instead. The fan and heating steps increase/decrease 6 or 9 steps (depending on the type of unit) and are only controlled by the room temperature. Actual Current stage is shown in the status screen.

The function current stage is activated in two ways:

Door that are always open

For a door that is always open, door mode Fixed open > can be selected under >Settings fan > Door mode.

Doors that are often open for longer periods

For a door that is often open Auto can be selected under Installer menu > Settings fan > Door mode. In Auto mode, the control automatically switches between Flexible and Open modes depending on how often the door has been open (when the door has been open for longer than 300 seconds the function changes from Flexible to Open).

Function description of current stage

The task of the Current stage function is to balance the room climate when a door is always open by using the right combination of fan and heating step.

In open mode, the room temperature is read every 60 seconds (during the first 6 cycles, and then every 5 minutes and at each reading any Current stage adjustments are made, i.e. fan control and supplied output adjusted.

Winter

When winter mode is selected under Main Menu > Summer / Winter.

- If the room temperature is more than 3 degrees below the current settings, the current stage increases by 2 steps.
- If the room temperature is between 1 and 3 degrees below the current settings, the current stage increases by 1 step.
- If the room temperature is more than 2 degrees above the current setting, the current stage decreases by 1 step.

Summer

When summer mode is selected under Main Menu > Summer/Winter, heating is blocked.

- If the room temperature is more than 2 degrees below the current settings, the current stage increases by 1 step.
- If the room temperature is between 1 and 2 degrees below the current settings, the current stage decreases by 1 step.
- If the room temperature is more than 2 degrees greater than the Current settings, current stage increases by 1 step.
- If the room temperature is between 1 and 2 degrees above current settings, the current stage decreases by 1 step.

If fan control has been max. limited under Main Menu > Fan control> High speed limit, all current stages will be used but the fan will be limited to the current setting.

See the table on the next page.

Table - Current stage for units with 5 fan controls

Current stage	Fan	Heating
0	0	0
1	1	0
2	2	0
3	2	1
4	3	1
5	3	2
6	4	2
7	5	2
8	5	3

Table - Current stage for units with 3 fan controls

Current stage	Fan	Heating
0	0	0
1	1	0
2	2	0
3	2	1
4	3	1
5	3	2

Control unit PLSUA1

Overview

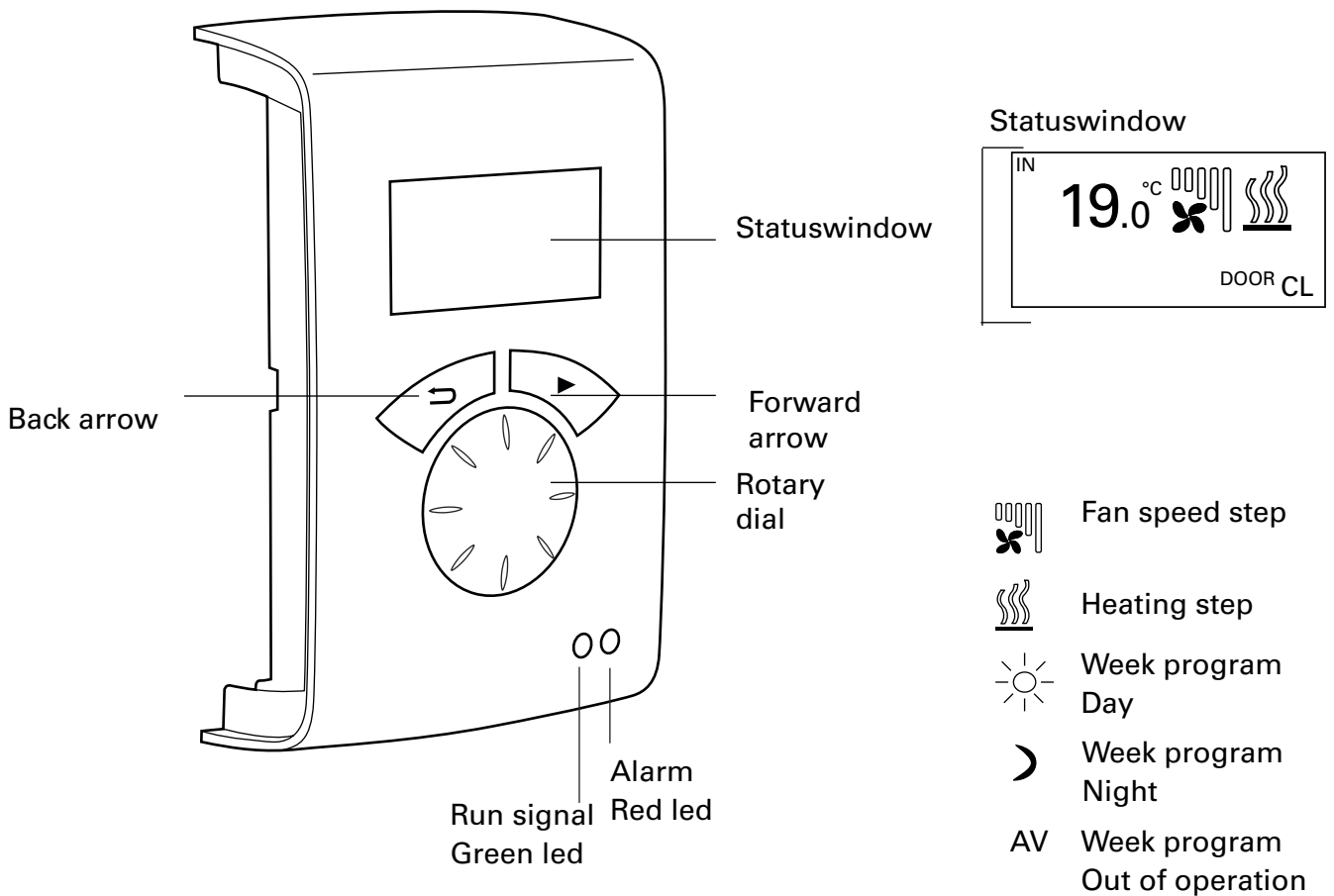

Explanations

Statuswindow

The display shows the prevailing room temperature, fan and heating step, door status and day/night mode or Off when the week program is used.

Forward arrow

Confirm selection and proceed.

Rotary dial

Scroll between alternatives

Back arrow

Go back.

After three minutes the control unit goes back to displaying the status window.

Statuswindow

Press forward arrow to enter the main menu.

Main menu

Current settings

Displays set room temp, high speed limit, Speed closed door, Summer / Winter and week program status.

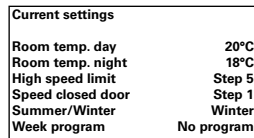
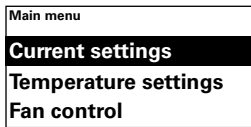

Temperature settings

Set the desired room temperatures to apply for day respectively night mode, when the door is closed (room temperature night is used for week program/night reduction).

At open door these set point values automatically increase with a set point differential that can be set under Installer menu > Heat settings> Open door setp. diff. (Factory setting 3.0 K).

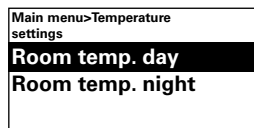
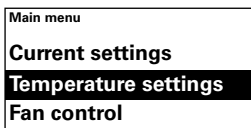

Factory setting

Room temp. day: 20°C (5 – 35°C)

Room temp. night: 18°C (0 – 20°C)

Fan control

Possibility of setting high speed mode at an open door and what speed should apply with a closed door (3 or 5 steps depending on the unit).

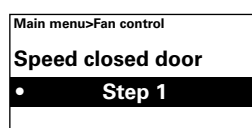
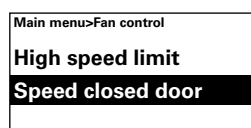
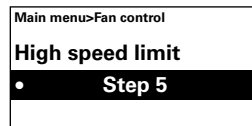
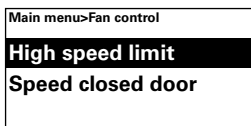
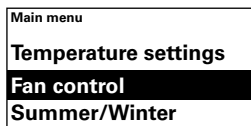

Factory setting

High speed limit: 3 resp. 5 (1-3, resp. 1-5)

Speed closed door: 1 (Off-3, resp. Off-4)

Summer/Winter

To permit or block heating. Heating is permitted in winter mode. Summer mode is displayed with a crossed out heating symbol in the status window.



Factory setting

Summer/Winter: Winter (Summer - heat off)

System on/off

Switch the whole unit off manually. In Off the display goes out; as soon as a button is pushed the display lights and shows System on/off. To activate the unit again select On.

The unit's safety functions are still active when the system is switched off, which means that the fan can continue to run for a moment after mode Off has been selected.

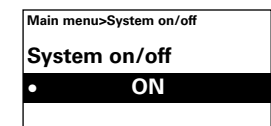
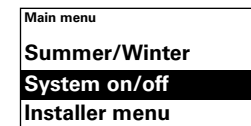

Installer menu

The installer menu is at the bottom of the main menu, this is password protected. See Installer menu in this manual.

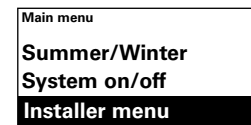

Installer menu

To enter the Installer menu, code 1932 is entered. Select the digits using the rotary dial and confirm using the forward arrow.



Installer status screen

Check the settings. The installer status screen consists of three pages with settings, scroll using the rotary dial.

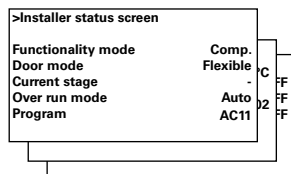
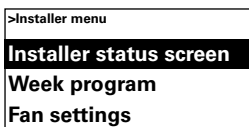

Week program

Make settings for week program.

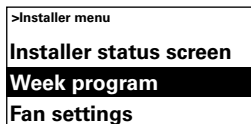

A basic program is pre-entered in PLS.
 Mon-Fri Day from 08:00, Night from 18:00
 Sat Day from 10:00, Night from 16:00
 Sun Day from 11:00:00, Night from 14:00

To check which program is set for a particular day, select Check program and then switch between the days using the rotary dial.

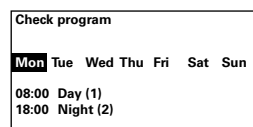

To check which days a certain program is active, select a week day by pressing the forward arrow, the program is marked and those days that the program is used will be underlined, switch between the programs for a particular day using the rotary wheel.

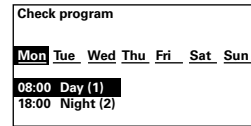

To add program step, select New program step. Confirm your selection with the forward arrow. Select Day, Night or Off (if the unit should not be in operation), set the time for switch on and then for which days the program applies, then go to End to finish.

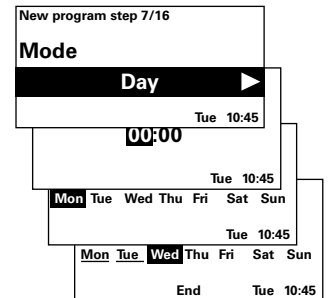
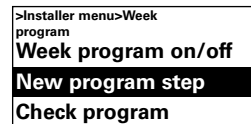

A new program step does not replace a set time for Day for example, but you can instead select to change a program step. To change a program step, select Change program.

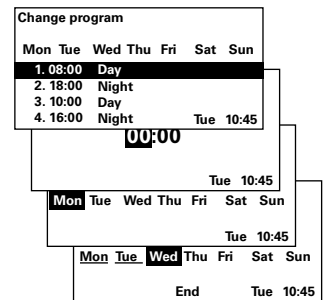
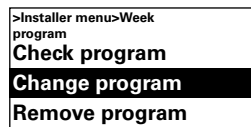

The program steps that should not apply are removed in Remove program. One or all program steps can be removed in the menu. To return to the factory set basic program, select Reset all.

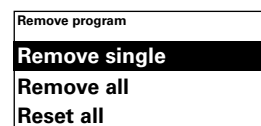

Week program is activated by selecting On, under Week program on/off. In On-mode, a sun, moon or Off in the Status window appears to indicate day, night respectively Off-function.

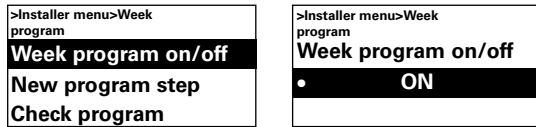

Fan settings

Make settings for fan mode (see also Operating modes section).

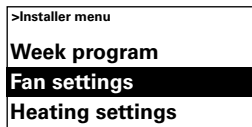

Door over run

Settings for overrun.

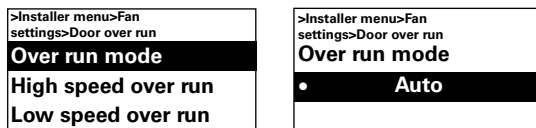
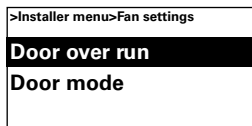

In over run mode Auto, PLS controls the over run time depending on how frequently the door is opened between openings, according to fixed preset values, according to the table.

Time between opening [s]	High speed over run [s]	Low speed over run [s]
t < 60	30	90
60 < t < 300	10	300
t > 300	0	180

Over run mode Fixed time is selected is one wants fixed over run times, the times can be changed during High speed over run and Low speed over run.

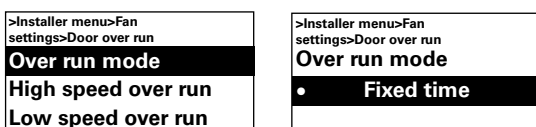

Factory setting

Over run mode: Auto (Set time)
 High speed over run: 30 s (0 – 180 s)
 Low speed over run: 120 s (0 – 300 s)

Door mode

There are three different door modes to choose from; Auto, Fixed flexible and Fixed open.

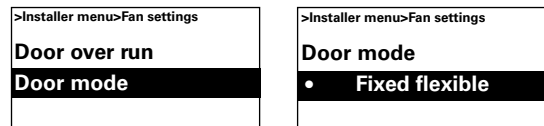

In Fixed flexible mode, the control function notes whether the door is open or closed. In Fixed open mode the door is considered always open and is only controlled according to Current stage. In Auto mode, the control automatically switches between Fixed flexible and Fixed open modes depending on how often the door has been open.

Factory setting

Door mode: Fixed flexible (Fixed open/ Auto)

Heating settings

Make settings for heating.

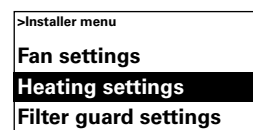

Open door setp. diff.

Set by how much the set point value (Room temp. day/night) is to increase when the door is open.

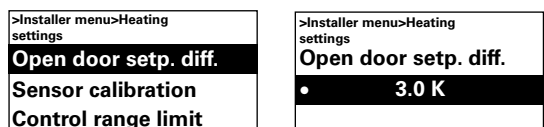

Factory setting

Set point value difference open door: 3.0 K (0 K – -10 K)

Heating step diff.

The temperature difference between connection of the electrical heating step.

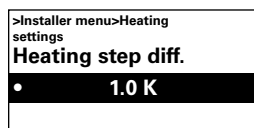
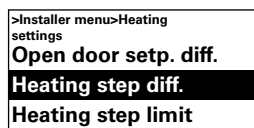

Factory setting

Heating step diff.: 1.0 K (-10 K – 10 K)

Heating step limit

Possibility of limiting the heating.

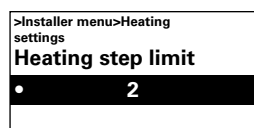
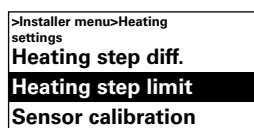

Factory setting

Heating step limit: 2/3 (1-2/3)

Sensor calibration

If the sensor displays the wrong values these can be calibrated. Some display errors may occur, but this is primarily due to the location (cold/hot surfaces etc). The value + or – adds to or subtracts from the measured value (for example +2K gives an increase of the displayed value of 2 degrees).

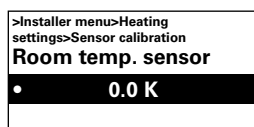
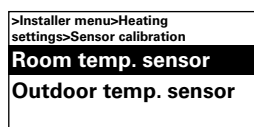
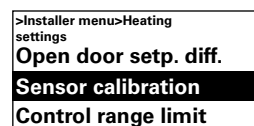

Factory setting

Room temperature sensor: 0.0 K (-10 K – 10 K)

Control range limit

The maximum room temperature that a user can select is limited to between 5 – 35°C.

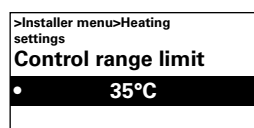
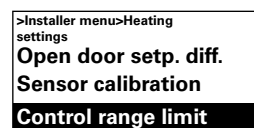

Factory setting

Control range limit temperature: 35°C (5 – 35°C)

Filter guard settings (not for electric)

Filter alarm alarms when the set fixed run time has been exceeded.

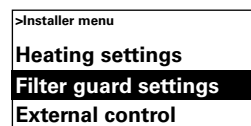

Filter timer setting

Under Filter timer setting, set the desired run time to between 50 and 9950 hours.

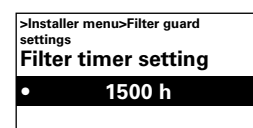

Factory setting

Filter timer setting: 1500 h (50 - 9950 h)

Filter timer on/off

Filter alarm is activated by selecting On, under Filter timer on/off.

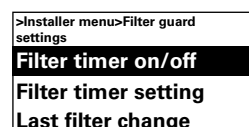

Factory setting

Filter timer on/off: Off (On)

Last filter change

To check the number of run time hours since the last filter replacement, select Last filter change. The time is reset when the filter alarm is reset. If the time is to be reset before the alarm has gone, switch the filter timer on and off.

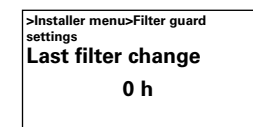

External control (BMS)

BMS functions can be activated under External control.

Activate External on/off (5-30V AC/DC from BMS) or 0-10V fan control by selecting On under the respective one. See diagram on next page and Connecting external control.

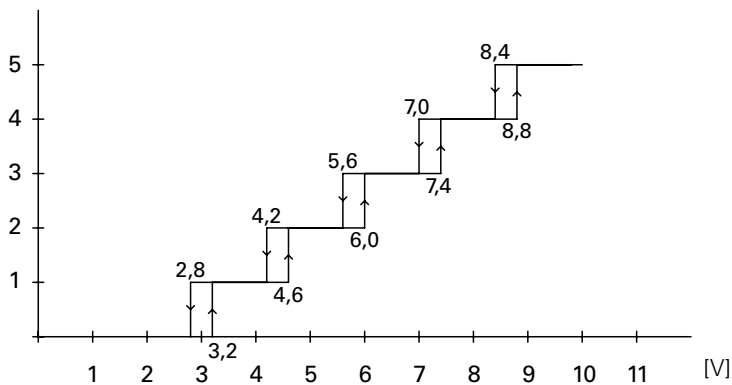
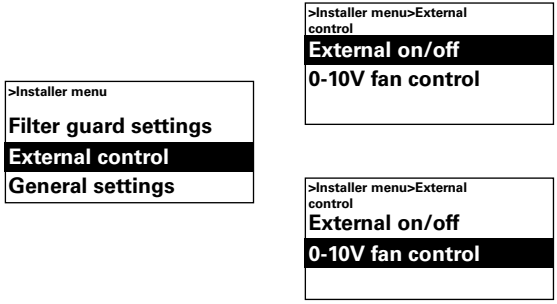

Diagram: Fan step at incoming 0-10V DC voltage level, 5 step

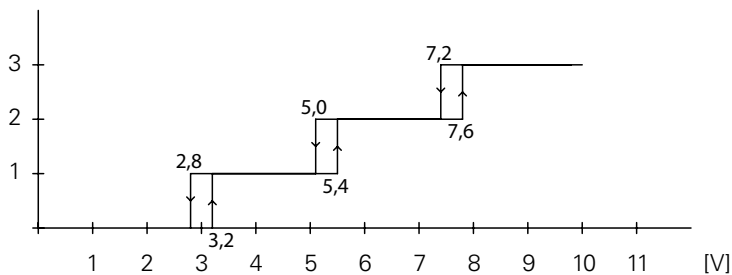
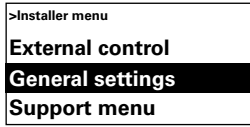

Diagram: Fan step for incoming 0-10V DC voltage level, 3-step.

General settings

Possibility of making general settings that are also in the Start-up wizard and execute user reset.



Change the date, time, language and temperature unit.

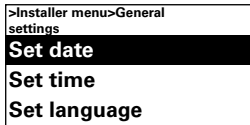

User reset

User reset (Room temp. day resp. night, high speed limit, speed closed door, door, Summer / Winter) to factory setting.

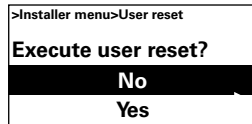
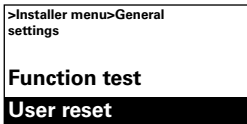

Function test

To test the fan and heating steps, run the function test.

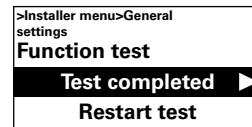
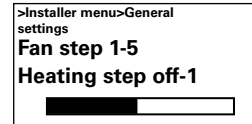
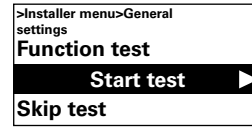

Service menu

The service menu is password protected and is used for support in contact with an authorised installer.

Alarm and error codes

PLS has different alarms and error codes for safe and problem free operation.

If alarms or error codes have been indicated these must be reset in order to return to normal operation, for example activating the heating again. Fan mode is active even when, for example, the over heating alarm has been indicated.

Displaying alarm and error codes

In event of alarm or error the alarm/error code is shown in the status window. In event of alarm/error code the unit it applies to is displayed.

See Table - Alarms and Table – Error codes.

Reset alarm

Note! Before resetting, check that the fault is rectified and there is nothing to prevent the unit from being recommissioned!

When the fault is rectified, the alarm is reset by pressing the forward arrow and selecting Reset alarm and then confirm. If several units give an alarm at the same time, the fact that there are several alarms is indicated, but only one is shown in the display. By resetting that alarm the next alarm can be read.

At the first start up alarm and error codes can occur, these can usually be reset without action.

Power failure

Note that in case of power failure the time settings need to be checked, if the time is not set correctly week program will be affected.

Overheat protection

Only applies to units with internal sensor. The over heating protection is intended to restrict the exhaust temperature to +40 °C. At 37 °C one output step is tripped off. If the temperature continues to rise all output is interrupted at 40 °C. If the temperature continues to rise despite this, for example because of a faulty contactor, the fan will start to spin at 50 °C to keep the temperature down. At the same time there is an over heating alarm (Table - Alarm). At internal temperatures of +54 °C the fan runs at maximum speed.

If the unit cools the output is engaged again. The alarm remains in the control unit's display. If the unit overheats twice within an hour, the alarm must be reset before the heating can be engaged again, the fan operates until the alarm is reset.

Note! In event of repeated alarms and over heating alarms, carry out a thorough check and if the fault cause cannot be found contact authorised service personnel.

Alarm	Cause	Action
A1 Motor alarm	Thermal switch has deployed. One or several motors have overheated. (Only units with withdrawn thermal switches.)	Check that nothing is obstructing the unit's air intake and exhaust. When the overheated motor has cooled the thermal switch shuts again and the alarm can be reset. At repeated alarms, check the motors, replace damaged motors.
A2 Over heating alarm	The temperature in the unit has exceeded the alarm limit for overheating. (Only applies to units with internal unit temperature.)	Check that nothing is obstructing the unit's air intake and exhaust, the function of the internal temperature sensor.
A4 Filter alarm	Fixed run time before the filter alarm has been reached.	Replace or clean the filter, adjust any alarm time based on how dirty the filter was and reset the alarm.
A5 Ext. alarm	External alarm input on PLSC1X has been activated.	Check the alarm.

Error code	Cause	Action
E1 Communication	PLSB1(X) has no contact with PLSC1X.	Check connection between the boards. Replace any modular cables.
E2 ID Error	Two or more PLSB1(X) have the same ID-number.	Interrupt the current and select different ID numbers for all PLSB1(X) in the system.
E3 ID Error	One or more PLSB1(X) do not have programs.	Contact support department.
E4 Room sensor error	Fault on or missing external room sensor PLSRTX connected to PLSB1(X).	Always disconnect the power when connecting or disconnecting sensors. Check connection of the sensor.
E8 Internal sensor faults	Fault on or missing internal sensor in the unit (applies to units with internal sensor).	Check connection of the sensor. If there is no sensor, contact support department.
E10 ID Error	Two or more PLSB1(X) in the system have different programs.	Contact support department.
E12 Room sensor error	Error in or missing external room sensor PLSRTX connected to PLSC1X.	Always disconnect the power when connecting or disconnecting sensors. Check connection of the sensor.
E20 Communication	Control unit PLSUA1 has no contact with PLSC1X.	Check the connection. Replace any modular cables.
E21 Room sensor error	Error in the internal room sensor in the control unit PLSUA1.	Check the connection between PLSUA1 and PLSC1X. Replace any modular cables. If the error is not rectified PLSUA1 must be replaced.
E23 Soft ware error	Contact support department.	Contact support department.

Connecting external control - including BMS functions

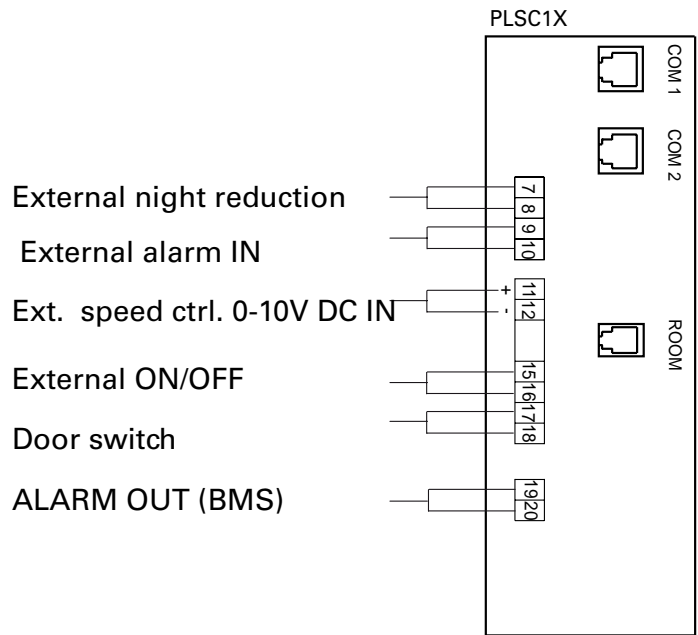
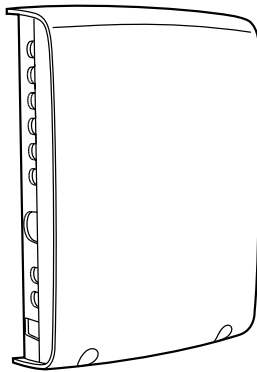

External night reduction on/off (potential-free switch)

Closes to activate the night reduction function. Always active.

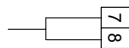

External alarm IN (potential free contact)

Input for external alarm. Closing gives alarm.

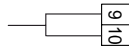

External speed control 0-10V DC

Controls the fan speed in steps (see diagram section External control (BMS)).

Set parameter: >> Installer menu > External control > 0-10V Fan control = On

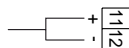

External on/off 5-30V AC/DC

External signal activates the unit.

Set parameter: >> Installer menu > External control > External On/Off= On

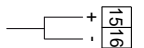

Door switch (obligatory) (External potential-free switch)

DC indicates door status. Potential-free switch from door automatic or BMS can also be used.

Closed = door open
Open = door closed

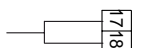

Alarm outgoing (BMS) (potential-free switch, max 3A, 230V)

Outgoing alarm indication.

Always active.
Closed = buzzer alarm
Open = no alarm

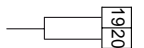

Wiring diagram - Competent
Internal PC Board Base

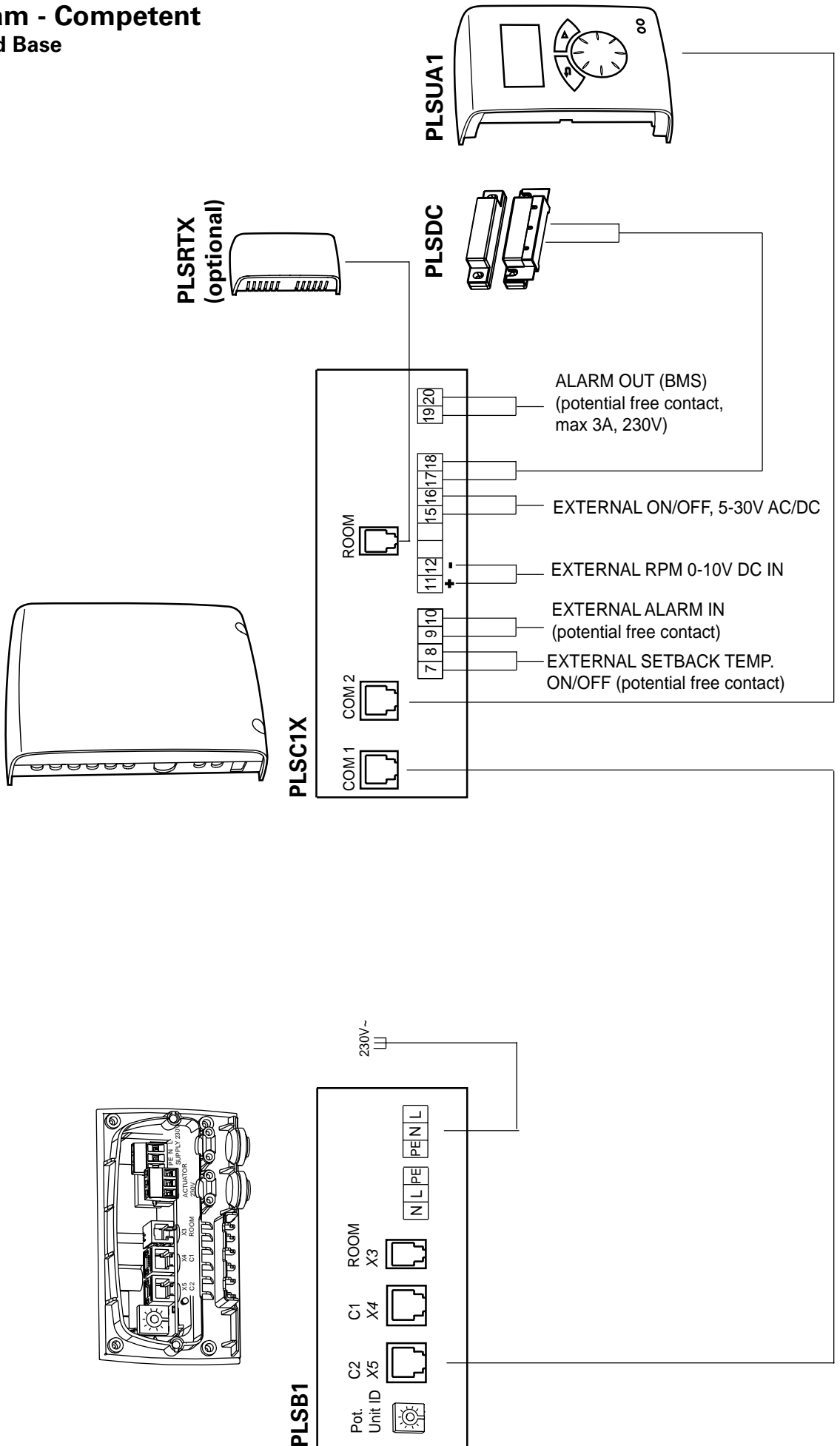

Wiring diagram - Competent
External PC Board Base

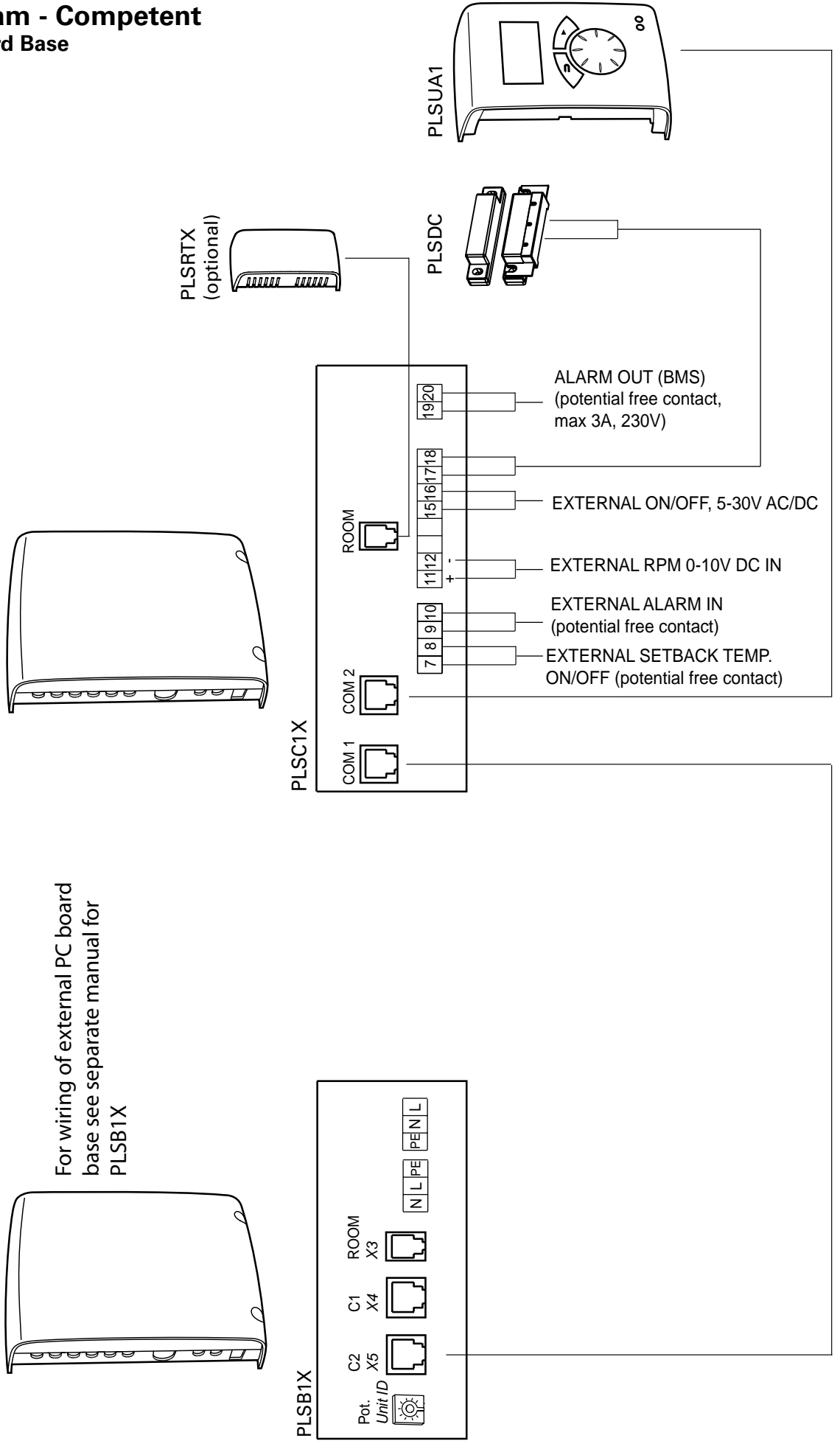

For wiring of external PC board
base see separate manual for
PLSB1X

Wiring diagram - Competent- parallell connection

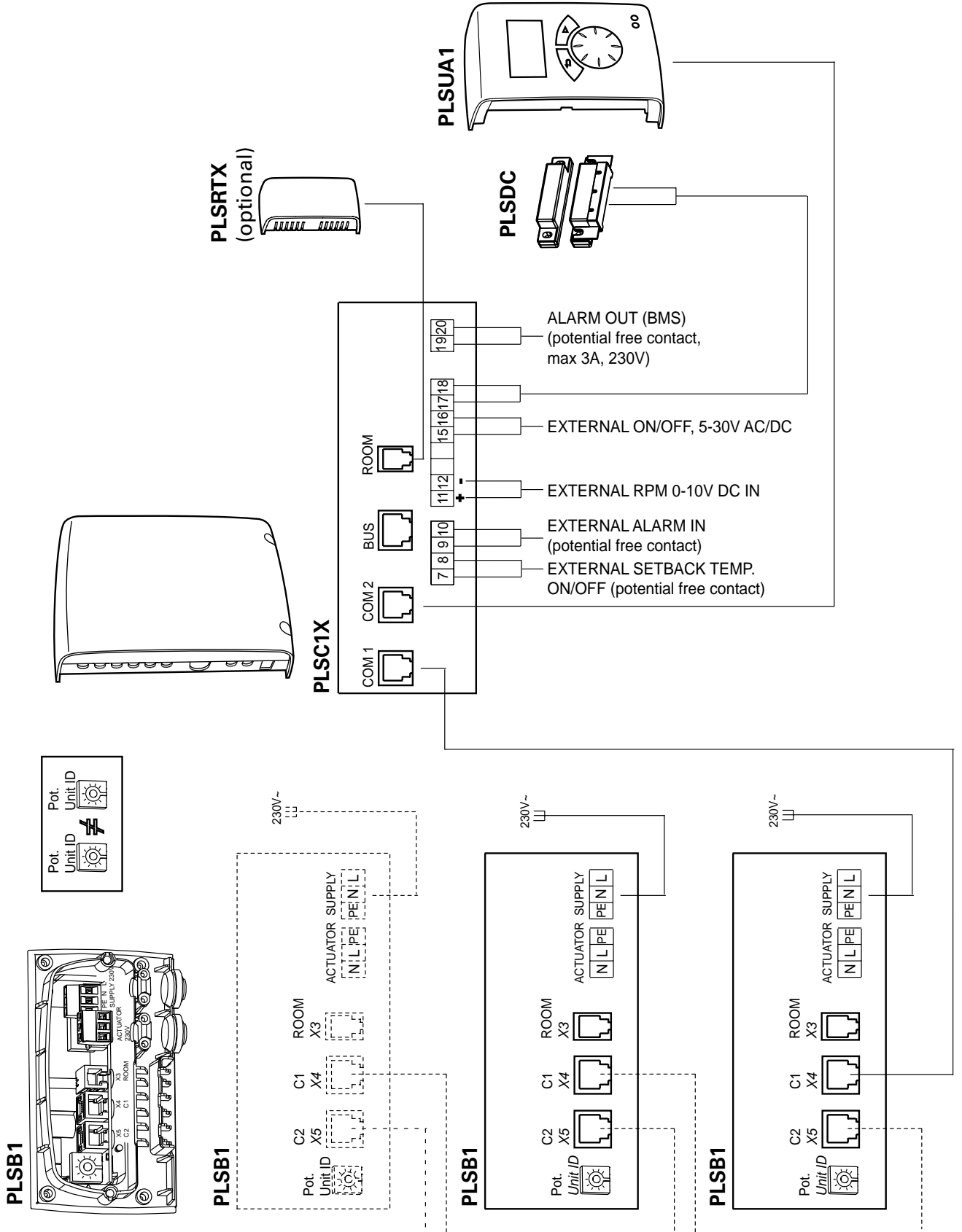

Technical Support - tel. +46 313368600